

# KTCM 512

ROOM TEMPERATURE CONTROL

ZONE CONTROL / 2-WAY



## PRESSURE INDEPENDENT BALANCING AND CONTROL VALVE – FOR MODULATING CONTROL

*High-performing and compact, these pressure-independent temperature control valves for variable flow heating and cooling systems, are especially suitable for fan-coil applications. Also suitable for use on the secondary side in district heating and comfort cooling systems. Rust protection is assured due to the electrophoretically painted ductile iron body.*



### INLINE DESIGN

*Allows high pressure drops without noise.*



### ADJUSTABLE FLOW

*Ensures the design flow.*



### SELF-SEALING MEASURING POINTS

*For quick and easy measurement.*

*we knowhow*

**TA**

# KTCM 512

## ROOM TEMPERATURE CONTROL

---

### TECHNICAL DESCRIPTION

---

**Application:**

Heating and cooling systems with variable flow.

**Functions:**

Temperature control, differential pressure control over the built-in control valve and flow control.

**Dimensions:**

DN 15-20

**Pressure class:**

PN 25

**Max. differential pressure ( $\Delta p_V$ ):**

800 kPa = 8 bar

**Pressure drop across control part of the valve ( $F_c$ ):**

LF/NF: 20 kPa

HF: 40 kPa

**Temperature:**

Max. working temperature: 120°C

Min. working temperature: -10°C

**Setting range:**

Maximum flow is adjustable up to 800 l/h (NF), 210 l/h (LF) and 1 150 l/h (HF).

Delivery setting: Position 10 (fully open).

**Media:**

Water and neutral fluids, water-glycol mixtures.

**Material:**

Valve body: Ductile iron EN-GJS-400

Diaphragms and gaskets: EPDM

**Surface treatment:**

Electrophoretic painting.

**Marking:**

TA, DN, PN, Kvs, material and flow direction arrow.

Identification ring on measuring point:

White = Low flow (LF)

Black = Normal flow (NF)

Red = High flow (HF)

**Max. lift of the control valve:**

4 mm

# KTCM 512

ROOM TEMPERATURE CONTROL



## Male thread x female thread

Threads according to ISO 228

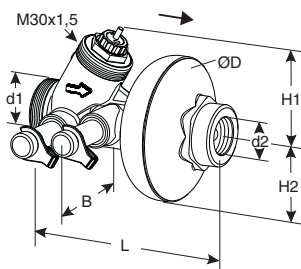

Fc = 20 kPa

TA No	DN	d1	d2	D	L	H1	H2	B	Kvd	Q <sub>max</sub> [l/h]	Kg
<b>KTCM 512 LF (low flow)</b>											
52 798-415	15	G1	G1/2	78	110	53	39	58	4	210	0,9
52 798-420	20	G1	G3/4	78	110	53	39	58	4	210	0,9
<b>KTCM 512 NF (normal flow)</b>											
52 798-515	15	G1	G1/2	78	110	53	39	58	4	800	0,9
52 798-520	20	G1	G3/4	78	110	53	39	58	4	800	0,9

Fc = 40 kPa

TA No	DN	d1	d2	D	L	H1	H2	B	Kvd	Q <sub>max</sub> [l/h]	Kg
<b>KTCM 512 HF (high flow)</b>											
52 798-615	15	G1	G1/2	78	110	53	39	58	4	1 150	0,9
52 798-620	20	G1	G3/4	78	110	53	39	58	4	1 150	0,9

## Male thread

Threads according to ISO 228

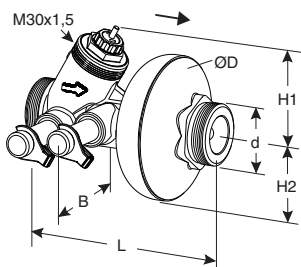

Fc = 20 kPa

TA No	DN	d	D	L	H1	H2	B	Kvd	Q <sub>max</sub> [l/h]	Kg
<b>KTCM 512 LF (low flow)</b>										
52 792-120	20	G1	78	110	53	39	58	4	210	0,9
<b>KTCM 512 NF (normal flow)</b>										
52 792-320	20	G1	78	110	53	39	58	4	800	0,9

Fc = 40 kPa

TA No	DN	d	D	L	H1	H2	B	Kvd	Q <sub>max</sub> [l/h]	Kg
<b>KTCM 512 HF (high flow)</b>										
52 795-920	20	G1	78	110	53	39	58	4	1 150	0,9

→ = Flow direction

Kvd = Is the Kv value of the differential pressure control component when fully open.

# KTCM 512

ROOM TEMPERATURE CONTROL

## CONNECTIONS

### With female thread

Threads according to ISO 228

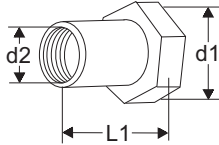

TA No	EAN	d1	d2	L1*
52 759-015	7318793546609	G1	G1/2	26
52 759-020	7318793546708	G1	G3/4	32

### With male thread

Threads according to ISO 7

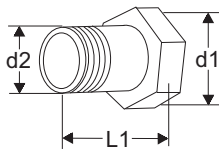

TA No	EAN	d1	d2	L1*
52 759-115	-	G1	R1/2	34
52 759-120	-	G1	R3/4	40

### For welding

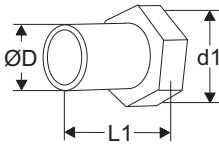

TA No	EAN	d1	D	L1*
52 759-315	7318793547200	G1	20,8	37
52 759-320	7318793547309	G1	26,3	42

\*) Fitting length (from the gasket surface to the end of the connection).

## ACCESSORIES

### Presetting tool

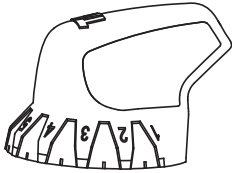

TA No	EAN
52 133-100	7318793886002

### Actuator TSE-M

#### 24V AC

For more details of TSE-M, see separate catalogue leaflet.

KTCM 512 is developed to work together with the TSE-M actuator. Actuators of other brands require a working range of:

X = 11,50 - 15,80 (closed - fully open)

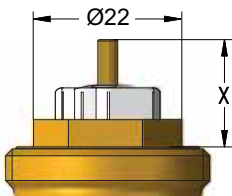

Tour & Andersson (TA) will not be held responsible for the control function if actuators other than TSE-M are used.

## OPERATING FUNCTION

The control valve with integrated balancing (1) and the diaphragm operated differential pressure controller (2) are built in series in a common valve body.

Pressure upstream of the control and balancing part of the valve acts through an internal impulse pipe to the inlet side of the diaphragm (3).

Pressure downstream of the control and balancing part of the valve acts to the outlet side of the diaphragm together with a spring force (4).

The spring force corresponds to a 20 kPa (LF/NF) or 40 kPa (HF) pressure difference on the diaphragm. The pressure from the differential pressure controller relieves the control and balancing part of the valve, and at the same time limits the flow to the preset value.

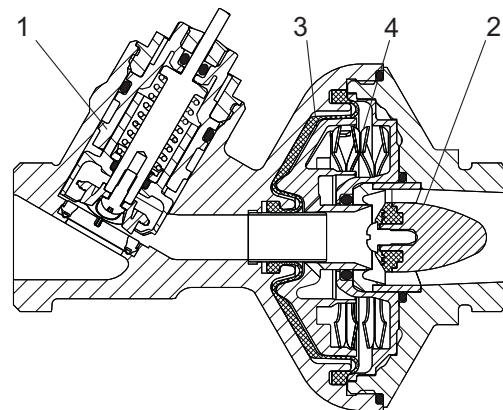

# KTCM 512

ROOM TEMPERATURE CONTROL

## INSTALLATION

Install in supply or return pipe. Flow direction is shown by the arrow on the valve body. Install the valve so that the control and balancing part of the valve and the measurement points are accessible. Check allowed positions of the actuator.

Installation of a strainer upstream of the valve is recommended.

Install the actuator after performing a leakage test.

### Application example

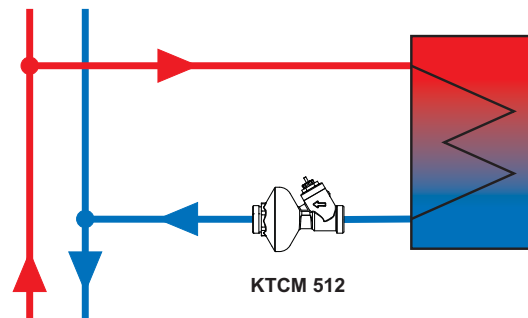

## SETTING

KTCM is delivered preset at position 10 (fully open).

Presetting of a valve for a given flow, e.g. corresponding to position 8, is done as follows:

1. Place the presetting tool, TA No 52 133-100, at the valve.
2. Turn the presetting tool so that position 8 is pointing at the index\* of the valve body.
3. Remove the presetting tool. The valve is now pre-set.

The charts under “Flow measuring” show flow at various positions of presetting.

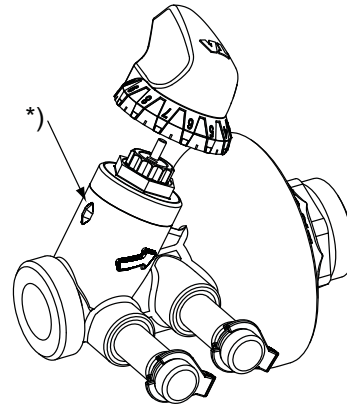

## SIZING

The valve is capable of a maximum flow of 210 l/h (LF), 800 l/h (NF) or 1 150 l/h (HF).

Minimum pressure drop needed for the valves to operate are 25 kPa (LF/NF) and 45 kPa (HF).

## FLOW MEASURING

To measure the flow through the valve, use TA's balancing or measuring instruments. The actuator must be in fully open position or removed. The measuring points are self-sealing. Remove the caps and insert the probes through the seals. After measuring replace the caps.

### KTCM 512 LF (low flow)

Position	Flow [l/h]	Kv
1	35	0,06
2	45	0,10
3	75	0,16
4	105	0,23
5	135	0,28
6	160	0,35
7	170	0,37
8	180	0,40
9	195	0,44
10	210	0,47

### KTCM 512 NF (normal flow)

Position	Flow [l/h]	Kv
1	70	0,15
2	85	0,18
3	115	0,22
4	195	0,40
5	290	0,61
6	350	0,78
7	410	0,96
8	550	1,20
9	710	1,62
10	800	1,90

### KTCM 512 HF (high flow)

Position	Flow [l/h]	Kv
1	100	0,15
2	125	0,18
3	150	0,22
4	265	0,40
5	405	0,61
6	505	0,78
7	605	0,96
8	775	1,20
9	1025	1,62
10	1150	1,90

Recommended setting: Position 3-10

## MEASURING ACCURACY

### Kv deviation at different settings

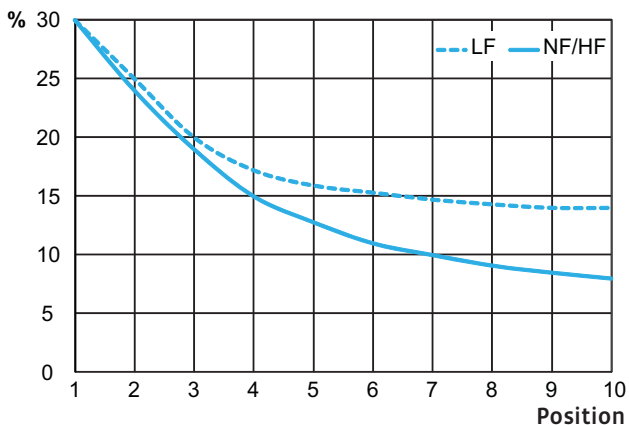

The products, texts, photographs, graphics and diagrams in this document may be subject to alteration by Tour & Andersson without prior notice or reasons being given.

For the most up to date information about our products and specifications, please visit [www.tourandersson.com](http://www.tourandersson.com).

6-10-27 KTCM 512 2009.12